

Edge Profiles

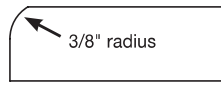

B
3/4" only
Rabbet: 7/16" deep
3/8" high



B-2*⁺
3/4" and 1"
Available w/MDF

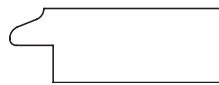

C
3/4" only
Rabbet: 7/16" deep
3/8" high



C-2*⁺
3/4" and 1"
Available w/MDF

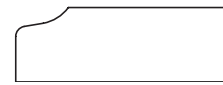

CFP-2*⁺
3/4" and 1"



E-2*⁺
3/4" and 1"



FP
3/4" only



H-2*⁺
3/4" and 1"
Available w/MDF



J-2*⁺
3/4" and 1"

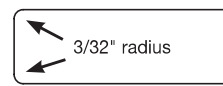

L-034*⁺
3/4" and 1"
Available w/MDF

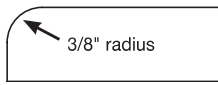

L-059*⁺
3/4" and 1"
Available w/MDF



L-120*⁺
3/4" and 1"

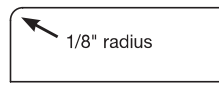

L-149*⁺
3/4" and 1"
Available w/MDF

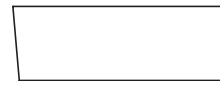

L-253
3/4" and 1"
5° back bevel
Available w/MDF



L-281*⁺
3/4" and 1"



L-382*⁺
3/4" and 1"
Available w/MDF

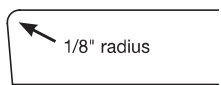

L-686
3/4" and 1"
5° back bevel
Available w/MDF



L-772*⁺
3/4" and 1"

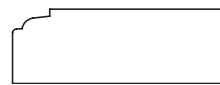

L-803*⁺
3/4" and 1"
Available w/MDF

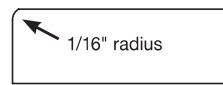

L-1160*⁺
3/4" and 1"
Available w/MDF



LC-2*⁺
3/4" and 1"
Available w/MDF



Machine Edge*⁺
3/4" and 1"
Available w/MDF



PRS-2*⁺
3/4" and 1"
Available w/MDF



RC-2*⁺
3/4" and 1"



V-2*⁺
3/4" and 1"
Available w/MDF

Premium Edge Profiles

\$14 additional charge per door.
These three profiles require 2 additional working days.



L-297*⁺
3/4" and 1"



L-304
3/4" and 1"
5° back bevel



LC-Inset*⁺
3/4" and 1"

FEP Rabbet Option

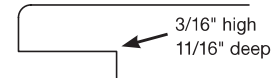





L-149 edge with FEP rabbet option

- Designed for use as a "finished end panel" to be used with Conestoga Cabinet Systems.
- All profiles marked with a + indicate FEP rabbet option is available.
- Available on 3/4" designs only.

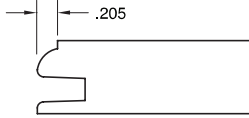
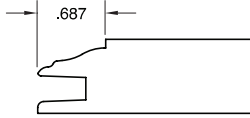
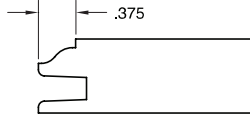

* Drilling for concealed hinges is available on doors with these profiles.
+ FEP Option available.
Images shown are not to scale.

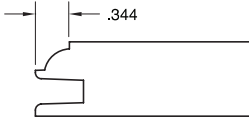
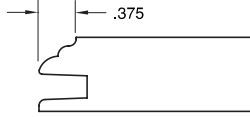
Not all framing beads and panel raises are available with all door designs – See Options and Availability pages. Design Charges include choice of published framing bead and panel raise.

Framing Beads

 <p>Regular 3/4" and 1"</p>	 <p>Elite 3/4" only</p>	 <p>Ogee 3/4" and 1"</p>	 <p>Square 3/4" and 1"</p>
 <p>F-007 3/4" only</p>	 <p>F-877 3/4" only</p>	 <p>F-1223 3/4" only</p>	

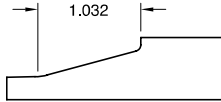
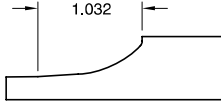
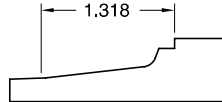
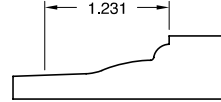
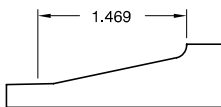
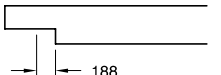
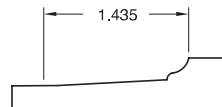
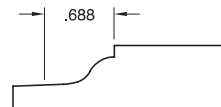
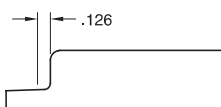
Panel Raises (dimensions shown are for 3/4" thick products only)

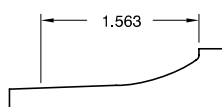
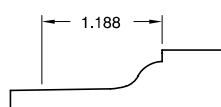
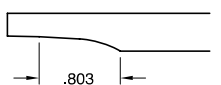
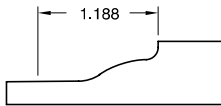
 <p>Slant 3/4" and 1"</p>	 <p>G-Cove 3/4" and 1"</p>	 <p>Louis XIII 3/4" only</p>	 <p>M-Bead 3/4" and 1"</p>
 <p>P-008 3/4" and 1"</p>	 <p>P-057 3/4" and 1"</p>	 <p>P-106 3/4" only</p>	 <p>P-125 3/4" only</p>
 <p>P-225* 3/4" only</p>	 <p>P-420 3/4" only</p>	 <p>P-602 3/4" only</p>	 <p>Presidential 3/4" only</p>
 <p>Reverse G-Cove 3/4" and 1"</p>	 <p>RM 3/4" and 1"</p>		

*P-225 raise not available when Colourtones, primers or Prism Paints are ordered.

All published 3/4" and 1" raises are available in hybrid products. Hybrid products consist of MDF panel and solid wood framing. 3/4" thick doors measure 5/8" finished panel thickness except Reverse G-Cove and P-057 which measure 3/8" thick and P-106 which measures 1/2" thick.

1" thick doors measure 3/4" finished panel thickness except Reverse G-Cove and P-057 which measures 1/2" thick.

Images shown are not to scale.

Options

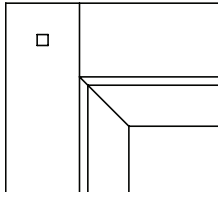

5/16" Square and Diamond Pegs

- For F-007, F-877, F-1223, Regular, Ogee and Square framing beads, pegs will be centered on stile one half of the total width of the stile and one half of the total width of the rail.
- For Elite framing bead submit dimensioned sketch showing peg location.
- When ordering two pegs per corner, specify either diagonal square or diagonal diamond pegs.
- Pegs will be sanded flush with face of framing.
- Available in all published species; peg specie must be specified.
- Multi-panel doors will be drilled for one peg at each interior joint, if requested.

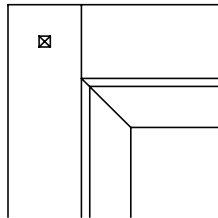
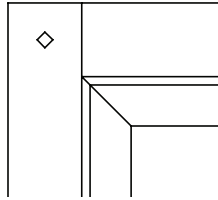

5/16" Pyramid Pegs

- Pyramid pegs will ship loose and doors will be pre-drilled to accept pegs.
- Pegs will be centered on stiles one half of the total width of the stile and one half of the total width of the rail.
- For Elite framing bead submit dimensioned sketch showing peg location.
- When ordering two pegs per corner, order as diagonal pyramid pegs.
- Multi-panel doors will be pre-drilled for one peg at each interior joint if requested.
- Available in all published species; peg specie must be specified.

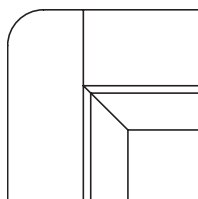
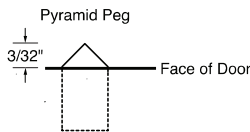

Radius Corners

- Specify 1/8", 1/4", 1/2" or 1" radius.
- Available with B-2, C-2, CFP-2, H-2, L-059, L-149, L-281, L-772, L-1160, LC-2, Machine Edge, PRS-2 and V-2 edge profiles only.

Options (continued)

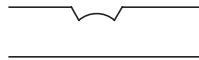
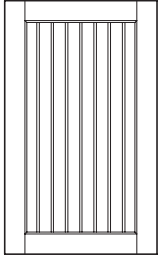

Groove width: 1/4"
Groove depth: 1/16"

G-012 Panel Groove

- 1-1/2" spacing from center of groove to center of groove standard. Groove pattern begins from center of panel.
- Custom spacing available upon request.

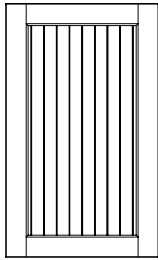

Groove width: 3/32"
Groove depth: 3/64"

G-015 Panel Groove

- 1-1/2" spacing from center of groove to center of groove standard. Groove pattern begins from center of panel.
- Custom spacing available upon request.

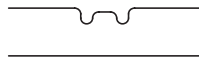
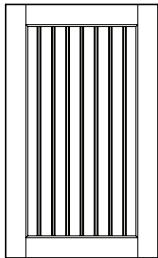

Groove width: 3/8"
Groove depth: 1/8"

G-056 Panel Groove

- 1-1/2" spacing from center of groove to center of groove standard. Groove pattern begins from center of panel.
- Custom spacing available upon request.

Options (continued)

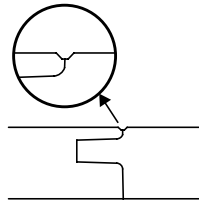
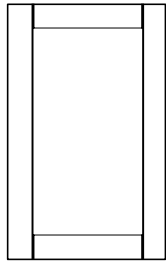

Essex Rout

- Rout is machined on full length of stiles.
- Rout is approximately 3/32" wide x 1/32" deep.
- Cannot be used with applied moulding designs, CRP-1389MT, CRP-10141, CRP-10605MT, CRP-10751MT, Fairhaven, Madison, miter designs or Presidential series.
- Add 1 day to lead-time.

Hybrid Panel Prep & Seal Option

- \$2.50 list per panel.
- Hybrid doors and drawer fronts consist of 5-Piece construction utilizing solid wood framing with MDF panels. The MDF panel eliminates stave to stave glue lines that are sometimes visible after painting solid wood panels, as well as veneer seams and splits in plywood panel products.
- The Hybrid Panel Prep & Seal Option eliminates the problematic step of sealing machined areas of MDF panels in an assembled door. This option is especially recommended for products utilizing raised panels.
- This Prep & Seal Option consists of the application of a sealant on the machined areas of the panel. After curing, the sealant is scuff sanded to provide a smooth, finish ready surface. Normal prep sanding of the solid wood framing is still necessary.
- The Hybrid Panel Prep & Seal Option is valid only with unfinished doors and drawer fronts.

MDF 1-Piece, 5-Piece and Hybrid Seal Coat Option

- 1-Piece MDF.
- 5-Piece MDF and 5-Piece Hybrid.
- The Hybrid and MDF Seal Coat Option consists of an initial machine sanding step in the manufacturing process, followed by the application of a sealant on the face and all machined surfaces including the panel raise, framing bead and edge profile. No sealant is applied to the back and there is no further sanding after the seal coat is applied to the face. Must be scuff sanded by customer before primer is applied.
- Solid wood framing in Hybrid products may show wood characteristics such as pin knots, sap pockets on Cherry and mineral streaks.
- Testing for compatibility and adhesion between Conestoga's Seal Coat and customer's finish materials should take place on a sample door prior to finishing any large items or multi-piece projects. We recommend only **acid cured conversion varnish topcoats**. Conestoga assumes no responsibility for incorrect application of finish materials by the customer that may result in poor adhesion, color mismatch or other finish related issues. Conestoga will not warrant products due to incompatibility issues between our seal coat and non-DuraGuard finish materials.
- All 1-Piece MDF, 5-Piece MDF and 5-Piece Hybrid doors and drawer fronts are available to receive this option.
- This option is available on Hybrid and MDF unfinished products only.
- Add 1 day to lead-time.

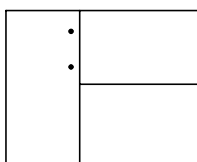
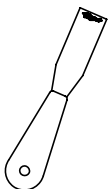

Putty Pin Holes

Options (continued)

End Grain Sealant Option

- \$5.95 list per door or drawer front. Multi-panel products will incur a charge per panel.
 - Sealant is applied to the end grain of the panel raise and framing which results in a more uniform appearance between the end grain and face grain after finish is applied. While the End Grain Sealant Option will greatly improve the end grain appearance, end grain will still appear somewhat darker than non-end grain areas.
 - The End Grain Sealant Option is available on all published species, panel raises and edge profiles.
 - The End Grain Sealant Option is available with wiping and spray stains with the exception of Bordeaux, Dark Roast, Espresso, Nickel and Nitefall. End Grain Sealant Option is not available with primers, Colourtones or Prism Paints.
 - Add 1 day to lead-time.
-

Wood Conditioner Option

- Sanding methods used to sand the face of contoured miter framing differs from how center panels are sanded. Depending on specie and finish combinations chosen, stains sometimes absorb quite differently between components resulting in a picture frame effect.
- To minimize color contrast between framing and panels, Conestoga developed a process to apply a wood conditioning treatment to the face of contoured miter framing, crown and trim mouldings. The result is a more uniform finished appearance of all components.
- Available on unfinished and finished miter doors and drawer fronts that meet both the design and specie criteria listed below.
- List pricing for the Wood Conditioner Option:
 - ◆ Doors and wainscot panels.
 - ◆ Drawer Fronts.
 - ◆ Mouldings: Wood Conditioner is automatically added to moulding finish pricing for applicable specie/finish combinations. Unfinished mouldings may receive this option for the following price:

8' length -	\$4.75 per stick
10' length -	\$5.50 per stick
12' length -	\$6.75 per stick
- Any door design with a flat surface on the framing face (regardless of construction type) is not eligible for the Wood Conditioner Option because the wide belt sanding process negates the effect of the conditioner.
- Eligible published miter designs: CRP-10191, CRP-10318, CRP-10334, CRP-10875, CRP-10946, CRP-1420, LaSalle, Prestige, Rothsford, TW-10875, Wellston and Woodridge.
- The Wood Conditioner Option is limited to select Alder, Cherry, Hard Maple, Soft Maple and White Birch mitred designs.
- Eligible finishes include Autumn, Chestnut, Colonial, Cordovan, Driftwood, Ginger, Harvest Gold, Honey, Portabella, Saddle and Washington Cherry wiping stains.
- Available on unfinished miter designs and species listed above. Wood Conditioner Option must be selected.
- All prefinished miter door and drawer front designs that meet the design, specie and finish criteria will automatically receive Wood Conditioner on framing. Customers have the option to decline this service, but must notify Customer Service via phone, email or through Con-Nex, our online ordering program.
- All prefinished mouldings that meet the specie and finish criteria will automatically receive Wood Conditioner.
- The Wood Conditioner Option does not include sealing center panel end grain. To further enhance the appearance of panel end grain, select the End Grain Sealant Option.

Options (continued)



Weathered Grain Option

- The Weathered Grain Option consists of random removal of surface material from panels, framing and edge profiles. Softer portions of the wood's surface are removed from the product's face, resulting in a highly textured look and feel.
 - On 5-piece products such as the CRP-10 door, only the face of the panel and framing and the outside edges of the door will receive the weathering process. Recessed machined areas such as panel grooves and framing beads will not be weathered.
- Only a limited portion of our product offering including door designs, profiles and species are eligible to receive the Weathered Grain Option. This offering was arrived at by running a series of tests on a wide variety of products and product options.
 - ◆ Eligible 3/4" door designs: Albany, Amesbury, Ardmore, Bristol, Cortland, Crossbuck, CRP-10, CRP-10 Pilaster, CRP-10102, CRP-20, CRP-30, Flush Batten, Lafayette, Prestwick, Radcliffe, Sheldon, Slab, Stockbridge, TW-10, TW-10 Pilaster, TW-1038, TW-10716, TW-10916 and Yardley. Select 1" thick designs and profiles available – contact Customer Service.
 - ◆ Eligible 3/4" species: Alder, Bamboo, Cherry, Hickory, Knotty Pine, Quarter Sawn White Oak, Red Oak, Rustic Knotty Alder, Rustic Knotty Cherry, Rustic Knotty Hickory, Rustic Knotty Red Oak, Thermally Treated Poplar, Walnut and White Oak. All species listed also available in 1", except Bamboo and Thermally Treated Poplar.
 - ◆ Eligible framing beads: F-1223, Regular and Square only. Framing beads will not receive the weathering feature.
 - ◆ Eligible panel raises: P-057, Reverse G-Cove, and plywood center panels.
 - ◆ Eligible edge profiles: L-034, L-149, L-1160 and Machine Edge – edge profiles receive the Weathered Grain Option.
 - ◆ Eligible options with Weather Grain: back routed hand pull, concealed hinge boring, cross grain sand (back only), cut down framing, distressing levels 1 and 2, à la carte distressing options except wormhole clusters, G-012, G-015, G-056 panel grooves, putty pin holes, Soss hinge boring and wear sanding.
 - ◆ Eligible finishes: all Colourtones, Prism Paints, Truetones and wiping stains, both with and without glazes are available. Finish options include Antiquing and Heirloom treatments. All finishes default to a 5° sheen topcoat, 15° sheen topcoat is also available upon request.

Note: the Weathered Grain Option increases fiber raise which results in minor sand through in random areas. This is not considered defective and may actually enhance the weathered appearance.
 - Maximum panel width is 26".
 - Complementary products: non-beaded front frames, raised panel valances, slab fillers, fluted fillers, mouldings, S4S cabinet framing, B09 Beaded Panel, #13 Batten, #14 Scribe, #381 Baseboard, #538 Shaker Crown, #1126 Shaker Crown, #1529 Reverse Shaker Crown, #1809 Scribe, #2073 Refacer's Moulding, #2316 Scribe and #2317 Scribe.

Options (continued)

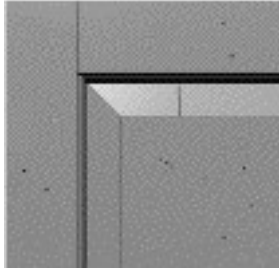

Rendering represents example only. Distressing is a random treatment; appearance of distressing will vary from piece to piece. A physical sample should be purchased before placing an order.

Distressing

- Level 1 – a random distribution of nicks and impressions.
- Level 2 – a random distribution of nicks and impressions, simulated wormholes, razor cuts and cut joints.
- Level 3 – a random distribution of nicks and impressions, simulated wormholes, rasp marks and cracks.
- Front frames, mouldings, ornaments and range hoods will receive modified distressing. Treatments on range hoods will be limited in intensity and will vary by style of hood.
- Not eligible on 1-Piece MDF, 5-Piece MDF or Hybrid products.
- Add 1 day to lead-time.

Distressing À La Carte

- Any of four distressing treatments can be ordered individually, or grouped in various combinations.
- Distressing treatments create a look of aged cabinetry that has withstood years of everyday use. Each treatment option will be applied in a random fashion to simulate varying degrees of wear.
- Not eligible on 1-Piece MDF, 5-Piece MDF or Hybrid products.
- Distressing treatment selections can be tailored to include one, two, three or four selections from the following options:
 - ♦ **Nicks and Impressions** – a number of indentations and nicks will be randomly applied across the face of the door or drawer front. Indentations of various shapes and sizes will be found on framing and panel.
 - ♦ **Rasp Marks** – located on the exterior edges of doors and drawer fronts, rasp marks are created by applying downward pressure on a large-tooth file which is dragged at an angle across the edge of the door's exterior profile.
 - ♦ **Razor Cuts & Cut Joints** – will give the appearance of splits or surface cracks radiating from the ends of framing or panel and will run parallel to the grain. Random cuts typically range from 2-1/2" to 5" in length and may vary in width. Cut joints consist of highlighting or widening random joints with a utility knife to create a look of joints that have slightly opened from years of stress and frequent use.
 - ♦ **Wormhole Clusters** – appearance of wormhole clusters will be spaced randomly on the face of the door or drawer front. Clusters will vary in size, shape and appearance.
- Pricing is based on a Design Charge plus a material square footage charge. The first option will incur a \$3.00 Design Charge, regardless of the treatment chosen. Each subsequent treatment will incur an additional \$1.75 Design Charge. The Material Charge will remain at \$.50 per square foot, regardless of the number of treatments selected.

Pricing example: Wormhole Clusters and Rasp Marks on a 15" x 25" door.

Wormhole Clusters + Rasp Marks + Material Charge = list.

Options (continued)

Cross Grain Sanding

- The Cross Grain Sanding Option is available only on unfinished doors and drawer fronts.
- Please note, even with cross grain removal, doors are not finish-room ready. To prepare properly for finishing, we recommend a light white wood sand.
- This option is automatically included at no charge on prefinished products.

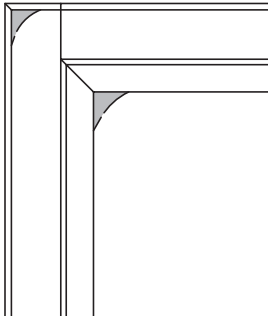

Wear Sanding

- The Wear Sanding Option provides an aged appearance to unfinished doors and drawer fronts. On raised panel designs, sanding is applied to the corners of the panel and the outside corners of the framing. Recessed panels, mullions and frame only designs will receive sanding on the outside corners of the frame. Sanding will be random and each corner will vary in appearance.
- Wear Sanding is available on range hoods, but will be limited in intensity depending on the style of hood selected.
- Wear Sanding is not available on front frames.

Antiquing

- Antiquing is a random post-finish sanding treatment that exposes raw wood corners and edges. This treatment provides a complementary worn look to our distressing packages.
- To achieve a heavier level antiquing, combine this option with the Wear Sanding Option.
- Antiquing is not available on front frames.
- Antiquing is available on range hoods, but will be limited in intensity and will vary by style of hood.

Options (continued)

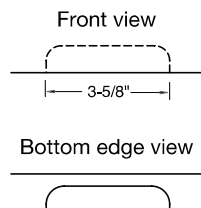
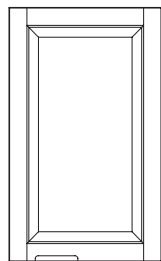

Back Routed Hand Pull

- Specify location: top or bottom and left, right or centered.
- Rout is 3-5/8" wide and 3/8" deep. When specifying left or right hand, pull will start 3" in from edge of door. Hand pull is centered on doors less than 10" wide.
- Available with the following published edge profiles: L-034, L-059, L-149, L-281, L-382, L-803, L-1160, LC-2, Machine Edge and V-2.
- Add 1 day to lead-time.

Non-Standard Width Framing

Non-Standard Width Framing (1-1/4" minimum size)

Only available on mortise and tenon constructed doors

Width	
1-1/4" to std. width	
Std. width to 6-7/16"	
6-1/2" to 8-3/4"	
*8-13/16" and wider	

*Stiles 8-13/16" wide and over automatically receive a mullion-type spline as a structural reinforcement.

Miter Bead Design with Non-Standard Framing Widths

CRP-10605MT, CRP-10751MT, CRP-1389MT,
Madison, Presidential & SavannahMT

Framing Width	
Std. width to 6-7/16"	
6-1/2" to 8-3/4"	
*8-13/16" and wider	

Add 4 days to lead-time.

Wide framing may contain one or more glue joints, depending on overall desired width. The chart below lists the number of glue joints allowed in the different framing widths. These glue joints are considered acceptable.

Framing Glue Joint Parameters

Framing Width	Number of Acceptable Glue Joints
2-3/8" to 4" width	1 glue joint is acceptable
4-1/16" to 6" width	2 glue joints are acceptable
Over 6" in width	2 or more glue joints are acceptable

Options (continued)

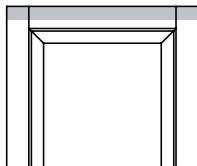
**Cut Down (Width or Height)**

- The Cut Down Option is available for Wood/MDF mortise and tenon doors and drawer fronts and 3-Piece and 5-Piece Intrigue, Strata and Vogue TTS Alternative Materials products that are manufactured to the minimum size and cut down to achieve a smaller size. This option is not available for mitered designs.

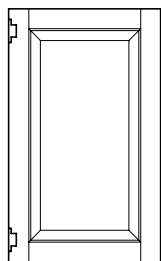
**Soss Hinge Boring**

- Assumes two bores.
- Routs are placed 9" off center, measured from the vertical center of the door to the start of the rout.
- Not available on doors over 42" high or under 25-1/8" high.

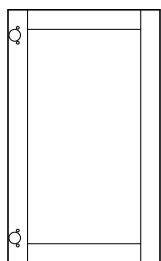
**Concealed Hinge Boring: Pattern "A" 2.5mm**

- Assumes two bores.
- Hole placement primarily designed for framed cabinetry.
- Boring consists of a 35mm diameter hole, 13.5mm deep with a 2.5mm tab dimension from the edge of the door.
- Insert holes are 8mm in diameter, 11.9mm deep, located 9.5mm from the center of the 35mm bore to the center of the 8mm insert bore.
- Specify with insert holes or cup only.
- Doors 8-13/16" – 42" long receive two bores.
- Doors 42-1/16" – 72" receive three bores (upcharge applies).
- Doors 72-1/16" and longer receive four bores with center holes set 25" in from each end (upcharge applies).
- Boring available on the following edge profiles only: B-2, CFP-2, H-2, L-034, L-059, L-149, L-281, L-297, L-382, L-803, L-1160, LC-2, LC-Inset, Machine Edge, PRS-2 and V-2.
- Concealed Hinge Boring is available on inset/prefit doors. Pattern "A" with or without insert holes, L-149, L-1160 and Machine Edge only.
- Pattern "A" accommodates the following hinge models for framed cabinetry:
 - Blum: Compact 33, 38C, 38N and 39C series.
 - Grass: TEC series.
 - Amerock: Matrix and 2811 series.
 - Mepla: ACC162 (screw-in version).
 - Salice: "S" series.
- Custom boring locations available. Specify dimension from top or bottom edge of door to center of cup locations.

With insert holes

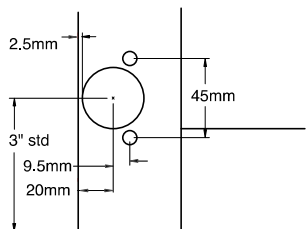

Cup Only

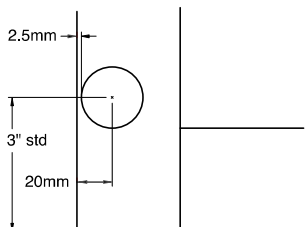

Options (continued)

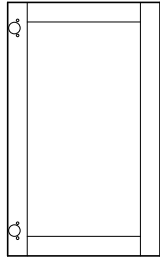

With insert holes

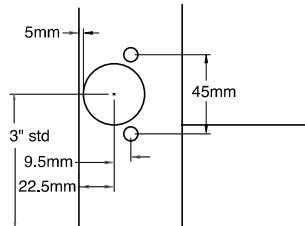

Cup Only

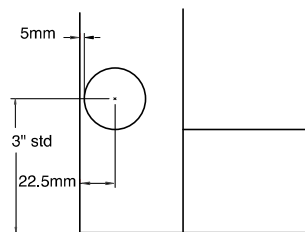
**Concealed Hinge Boring: Pattern "B" 5mm**

- Assumes two bores.
- Hole placement primarily designed for frameless cabinetry.
- Boring consists of a 35mm diameter hole, 13.5mm deep with a 5mm tab dimension from the edge of the door.
- Insert holes are 8mm in diameter, 11.9mm deep, located 9.5mm from the center of the 35mm bore to the center of the 8mm insert bore.
- Specify with insert holes or cup only.
- Doors 8-13/16"– 42" receive two bores.
- Doors 42-1/16"– 72" receive three bores with the third centered on the height of the door (upcharge applies).
- Doors 72-1/16" and greater receive four bores with center holes set 25" in from each end (upcharge applies).
- Boring available on the following edge profiles only: B-2, CFP-2, H-2, L-034, L-059, L-149, L-281, L-297, L-382, L-803, L-1160, LC-2, LC-Inset, Machine Edge, PRS-2 and V-2.
- Concealed Hinge Boring is available on inset/prefit doors with the following edge profiles: L-149, L-253, L-686, Machine Edge, L-947, L-967, L-304, L-996 and L-1160.
- Pattern "B" accommodates the following hinge models for frameless cabinetry:
 - Blum: 107, 120, 120+, 170, Diagonal 20, 30, 37, 45, Angle 25 and CLIP Top Series.
 - Grass: TEC, Nexis and Tiomos Series.
 - Salice: 200 Series (use 2mm mounting plate).
- Custom boring locations available - \$2.50 list per door. Specify dimension from top or bottom edge of door to center of cup locations.

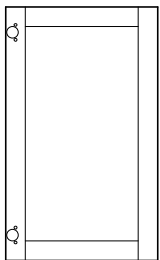
Concealed Hinge Boring: Pattern "C" 5mm

- Assumes two bores.
- Hole placement primarily designed for frameless cabinetry.
- Boring consists of a 35mm diameter hole, 13.5mm deep with a 5mm tab dimension from the edge of the door.
- Insert holes are 8mm in diameter, 11.9mm deep, located 9.5mm from the center of the 35mm bore to the center of the 8mm insert bore.
- Specify with insert holes or cup only.
- Doors 10"– 42" receive two bores.
- Doors 42-1/16"– 72" receive three bores with the third centered on the height of the door (upcharge applies).

Options (continued)

With insert holes

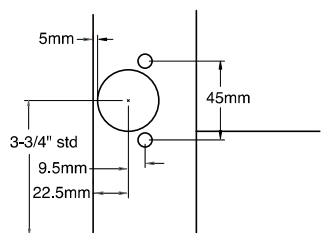

Cup Only

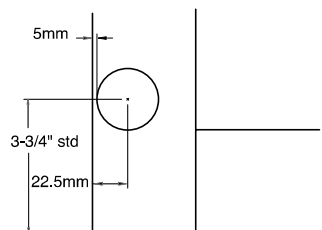
**Concealed Hinge Boring: Pattern "C" 5mm (continued)**

- Doors 72-1/16" and greater receive four bores with center holes set 25" in from each end (\$1.50 upcharge applies).
- Boring available on the following edge profiles only: B-2, CFP-2, H-2, L-034, L-059, L-149, L-281, L-297, L-382, L-803, L-1160, LC-2, LC-Inset, Machine Edge, PRS-2 and V-2.
- Concealed Hinge Boring is available on inset/prefit doors with the following edge profiles: L-034, L-149, L-253, L-686, Machine Edge, L-947, L-967, L-304, L-996 and L-1160.
- Pattern "C" accommodates the following hinge models for frameless cabinetry:
 - Blum: 107, 120, 120+, 170, Diagonal 20, 30, 37, 45, Angle 25 and CLIP Top Series.
 - Grass: TEC, Nexis and Tiomos Series.
 - Salice: 200 Series (use 2mm mounting plate).
- Custom boring locations available. Specify dimension from top or bottom edge of door to center of cup locations.

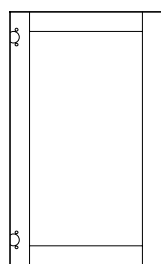

With insert holes

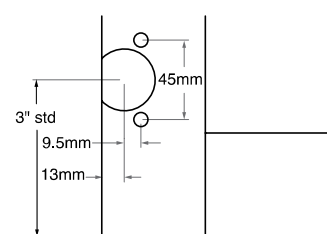

Cup Only

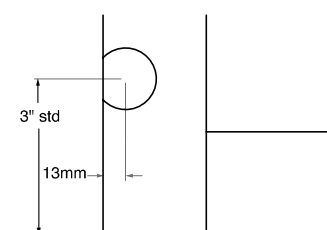
**Concealed Bi-Fold Hinge Boring**

- Hole placement is primarily designed for edge-mount style bi-fold hinges.
- Boring available on the following edge profiles only: B-2, CFP-2, H-2, L-034, L-059, L-149, L-281, L-297, L-382, L-803, L-1160, LC-2, LC-Inset, Machine Edge, PRS-2 and V-2.
- Boring consists of a 35mm diameter hole, 13.5mm deep, 12.5mm on center from edge of the door.
- Insert holes are 8mm in diameter, 11.9mm deep, located 9.5mm from the center of the 8mm insert bore.
- Specify with insert holes or cup only.
- Doors 9-1/2" – 42" receive two bores.
- Doors 42-1/16" – 72" receive three bores with the third centered in the height of the door (upcharge applies).
- Concealed bi-fold rout accommodates Blum's CLIP top 60 degree bi-fold hinge (CWS #2103583).
- Custom boring locations available. Specify dimension from top or bottom edge to the center of cup locations.

Options (continued)

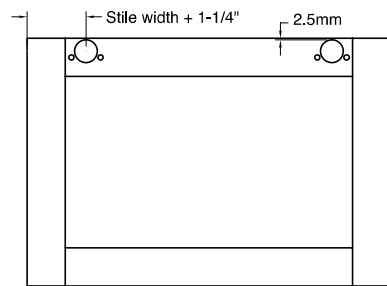

Pattern A

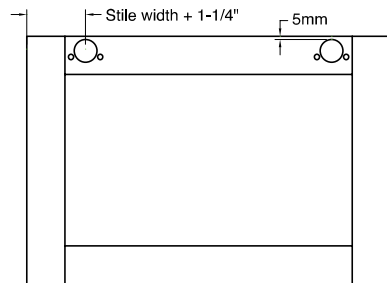

Pattern B

HK-XS Hinge Boring

- Boring location designed specifically for Blum HK-XS lift mechanisms (CWS#'s 2103577, 2103578, 2103579 and 2103580).
 - ♦ Door width range: 12" – 72".
 - ♦ Door height range: 9-3/8" – 24".
- Hole placement is designed to rail mount concealed framed or frameless style hinges.
- HK-XS Pattern A Rout has a 2.5mm tab dimension from the edge of the door, primarily for framed cabinetry.
- HK-XS Pattern B Rout has a 5mm tab dimension from the edge of the door, primarily for frameless cabinetry.
- Boring consists of a 35mm hole 13.5mm deep placed on each end of the door 1-1/4" + the stile width of the door design.
- Specify with insert holes or cup only.
- Insert holes are 8mm in diameter, 11.9mm deep, located 9.5mm from the center of the 35mm cup bore.
- Doors 12" – 42" receive two bores.
- Doors 42-1/16" – 72" receive 3 bores (upcharge applies).
- Boring available on the following edge profiles: B-2, CFP-2, H-2, L-034, L-059, L-149, L-281, L-382, L-803, L-1160, LC-2, Machine Edge, PRS-2, V-2, L-297 and LC-Inset.
- Custom boring locations are not available.

Aluminum Hand Pull

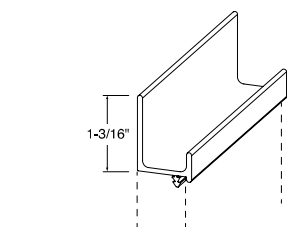
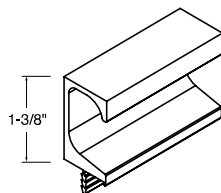
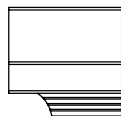
Front View
J-StyleSide View
C-Style

- Design Charge: per Slab door or drawer front, regardless of hand pull design selected.
- Material Charge:
 - J-Style – Natural Aluminum.
 - J-Style – Polished Chrome.
 - C-Style – Natural Aluminum.
- Widths: Min. doors – 2-3/4", drawer fronts – 6-3/8", Max. – 36".
- Available on all Intrigue, Strata and Vogue TTS Slab products, Synchronicity Super Matte Slab products and Mera and Vetro Synchronicity High Gloss Slab products.
- Not available with Sequential Grain Match Option.
- Doors and drawer fronts are routed on the top edge to accept hand pull – no options.
- Hand pulls are cut-to-size, labeled to match the corresponding panel, wrapped and shipped separately.
- Hand pulls are designed with an integrated inset spline. Silicone caulk or construction adhesive can be used to affix the hand pull to the panel.
- When ordering Slab doors or drawer fronts with the Aluminum Hand Pull Option specify the total height of the door, including hand pull. Conestoga will subtract the height of the hand pull and size the panel accordingly.
- When ordering Slab doors or drawer fronts with the hand pull option and concealed hinge boring, specify top or bottom for hand pull and left or right for hinge boring. For hinge bore to be located 3" from top edge, request 1-13/16" bore location on top/bottom of door.

Options (continued)



Wood/MDF Sample ID Label



Alternative Material Sample ID Label

Sample ID Label

- The Sample ID Label Option identifies specific attributes of door and drawer front samples. Labels are tack-free and easy to remove. It is intended to be replaced with your company's customized label.
- Available on doors and drawer fronts only; this option is not available on aluminum frame doors, specialty or accessory products.
- ID labels are available on unfinished and finished doors and drawer fronts.
- Sample ID labels utilize Conestoga nomenclature, customization is not available.
- Label content will vary depending on material selected.
- Wood/MDF label includes: Conestoga design, specie/grade, bead, raise, edge profile, selected options, finishing information and package date.
- Alternative Materials label includes: Conestoga Design, color, selected options, order number and package date.
- All finished doors or drawer fronts will receive a second disclaimer label along with an ID label.

Toe Kick Notch

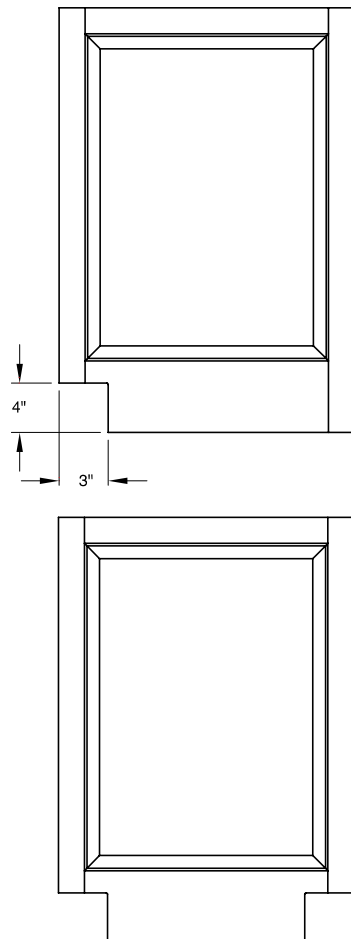

- Available in 3/4" thick 5-piece mortise and tenon doors with square bottom rails and Slab doors only.
- Standard Toe Kick Notch Option is 3" deep by 4" high and requires a bottom rail of 6" wide or greater. All other dimensions within the minimum and maximum depths and heights will be processed by Special Designs at no upcharge.
- Toe Kick Notch sizing is available in 1/16" increments.
- Minimum custom notch size is 2" deep by 2" high. Maximum custom notch size is 6" deep by 10" high.
- Width of bottom rail must exceed height of Toe Kick Notch by at least 2" to ensure joint integrity.
- Specify location of notch – left side, right side or with both left and right side notched.
- The inside corner of the Toe Kick Notch Option will have a 1/8" radius.
- Toe Kick Notch Option not valid with hinge boring.